

DRR245



REGOLATORE
Manuale Installatore

CONTROLLER
User Manual

PIXSYS



Summary

1	Introduction.....	3
2	Model identification.....	3
3	Technical data	3
3.1	General features.....	3
3.2	Hardware features	4
3.3	Software features	4
4	Dimensions and installation	5
5	Electrical wirings.....	6
5.1	Wiring diagram	6
6	Displays and keys functions	10
6.1	Numeric Indicators (Displays)	10
6.2	Meaning of Status Lights (Led)	10
6.3	Keys.....	11
7	Controller Functions	11
7.1	Modifying Main Setpoint and Alarm Setpoint Values	11
7.2	Auto-tune	12
7.3	Manual Tuning.....	12
7.4	Automatic Tuning.....	12
7.5	Soft Start.....	13
7.6	Automatic/Manual Regulation for % Output Control	13
7.7	Pre-programmed cycle	14
7.8	Memory Card.....	15
8	LATCH ON Function.....	16
8.1	Loop Break Alarm on Amperometric Transformer TA.....	18
8.2	Digital input Functions	19
8.3	Dual Action Heating-Cooling	20
9	Serial Communication	22
10	Configuration	26
10.1	Modify Configuration Parameter.....	26
11	Table of Configuration Parameters	27
12	Alarm Intervention Modes.....	38
13	Table of Anomaly Signals.....	43
14	Summary of Configuration parameters	44

1 Introduction

Thank you for choosing a Pixsys controller.

Controller DRR245 is specifically conceived for application on control panels with DIN rail mounting.

Pixsys makes available in a single device all the options relevant to sensor input and actuators command, in addition to the extended power range 24...230 Vac/Vdc. With 18 sensors to select and outputs configurable as relay, SSR command, 4...20 mA and 0...10Vdc, the user or retailer can reduce warehouse stock by rationalising investment and device availability. The series is completed with models equipped with serial communication RS485 Modbus RTU and with a loading control function via the amperometric transformer. The configuration is further simplified by the Memory cards which are equipped with internal battery and therefore don't require cabling to power the controller.

2 Model identification

DRR245-21-ABC-T	2 Relays 5A + 1 Ssr/V/mA + Rs485 +TA*
------------------------	---------------------------------------

* Input TA for Loop Break Alarm, supply 24...230 Vac/Vdc +/- 15% 50/60Hz - 3VA.

3 Technical data

3.1 General features

<i>Displays</i>	4 0,40 inch displays+ 4 0,30 inch displays
<i>Operating temperature</i>	0-45°C, humidity 35..95uR%
<i>Sealing</i>	IP65 front panel, IP20 casing and terminals
<i>Material</i>	PC ABS UL94VO self-extinguishing
<i>Weight</i>	165 g

3.2 Hardware features

<i>Analog input</i>	1: AN1 Configurable via software Input Thermocouple type K, S, R, J Automatic compensation of cold junction from from 0°C to 50°C. Thermoresistance: PT100, PT500, PT1000, Ni100, PTC1K, NTC10K (β 3435K) Linear: 0-10V, 0-20 or 4-20mA, 0-40mV, amperometric transformer TA 50mA 1024 points Potentiometers: 6K, 150K,	Tolerance (25°C) +/-0.2 % \pm 1 digit for thermocouple input, thermo resistance and V/mA. Cold junction accuracy 0.1°C/°C
<i>Relay outputs</i>	2 relays Configurable for command or alarm.	Contacts 5A-250V~
<i>SSR output</i>	1 linear 0/4...20mA /SSR/0...10Volt Configurable as command or retransmission of setpoint/process	Configurable: > SSR > 4-20mA, > 0...10Volt, > 0-20mA. Resolution 4000 points

3.3 Software features

<i>Regulation algorithms</i>	ON-OFF with hysteresis P, PI, PID, PD with proportional time
<i>Proportional band</i>	0...9999°C or °F
<i>Integral time</i>	0,0...999,9 sec (0 excluded)
<i>Derivative time</i>	0,0...999,9 sec (0 excluded)
<i>Controller functions</i>	Manual or automatic Tuning, configurable alarms, protection of command and alarm setpoints, activation of functions via digital input, preset cycle with Start/Stop.

4 Dimensions and installation

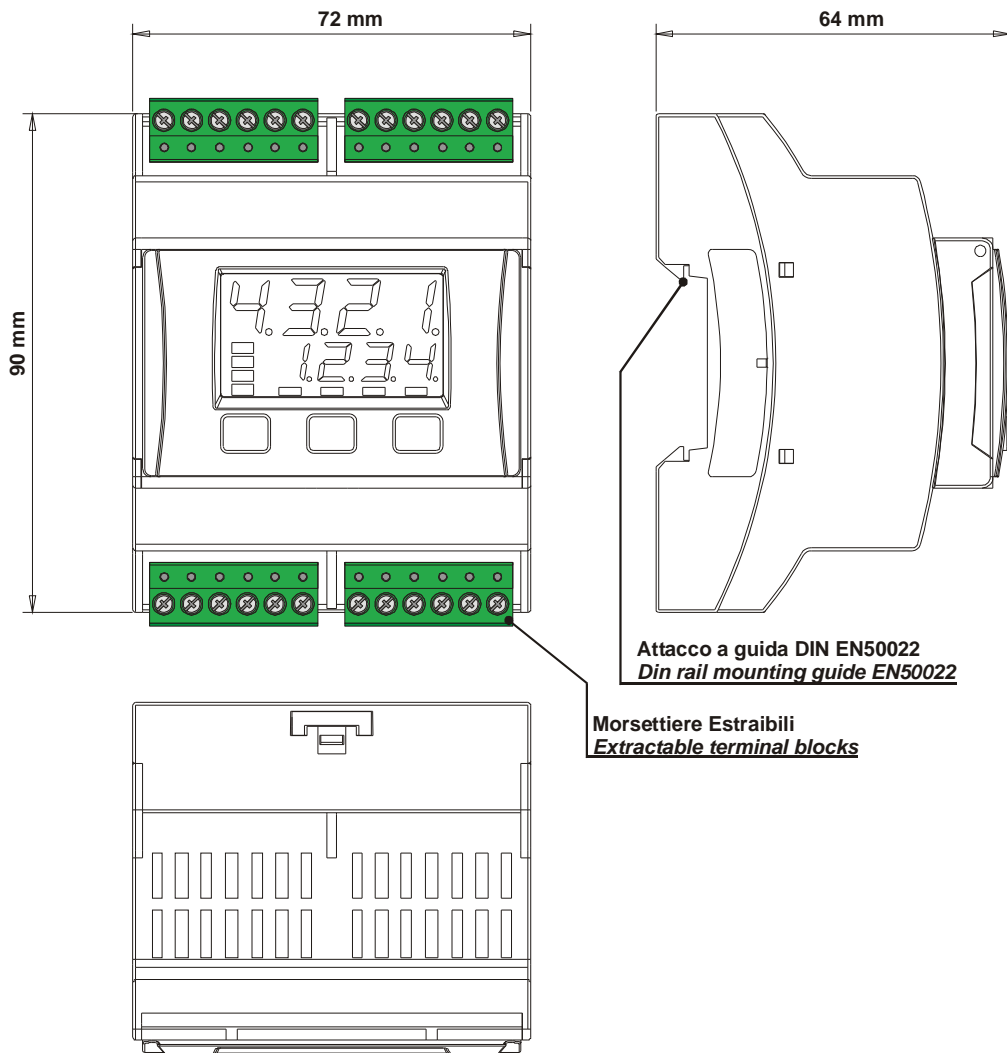

5 Electrical wirings



Although this controller was designed to resist noises in industrial environments, please notice following safety guidelines:

- Separate the feeder line from the power lines.
- Avoid placing near units with remote control switches, electromagnetic contactors, high powered motors and in all instances use specific filters.
- Avoid placing near power units, particularly if phase controlled.

5.1 Wiring diagram

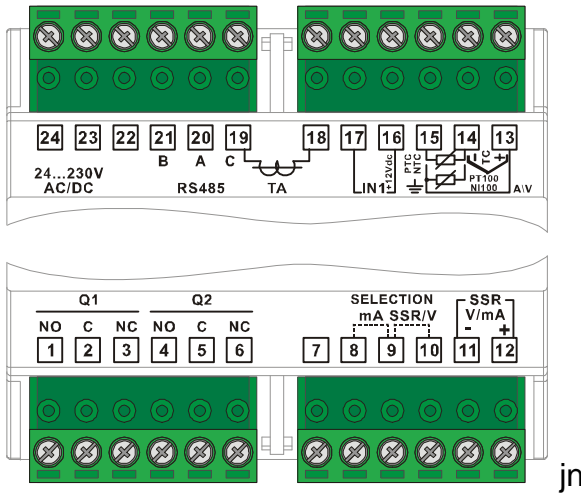

Power supply

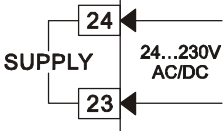

Switching power supply with extended range
 24...230 Vac/dc $\pm 15\%$ 50/60Hz - 3VA

Analog input AN1

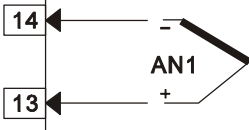

Thermocouples K, S, R, J.

- Comply with polarity
- For possible extensions, use a compensated wire and terminals suitable for the thermocouples used (compensated)

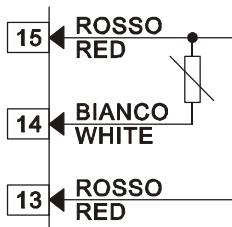

Thermoresistances PT100, NI100

- For the three-wire connection use wires with the same section
- For the two-wire connection short-circuit terminals 13 and 15.

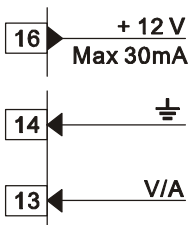
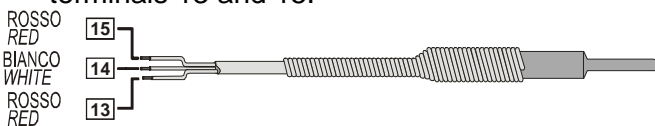

Linear signals V/mA

- Comply with polarity

Examples of Connection for linear input

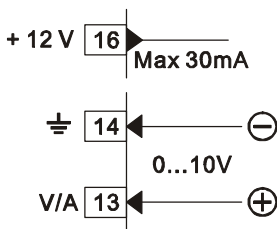

Linear signals 0...10V

Comply with polarity

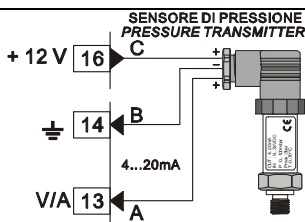

Linear signals 0/4...20mA

With three-wire sensor

Comply with polarity

A=Sensor output

B=Sensor ground

C=Sensor supply

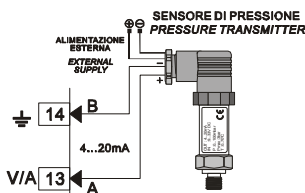

Linear signals 0/4...20mA with **external power of sensor**

Comply with polarity

A=Sensor output

B=Sensor ground

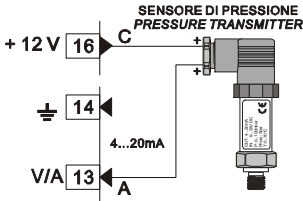

Linear signals 0/4....20mA with **two-wire sensor**

Comply with polarity
 A=Sensor output
 C=Sensor supply

Serial input

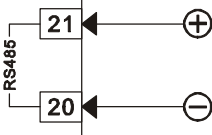

RS485 Modbus RTU communication

Relay output Q1

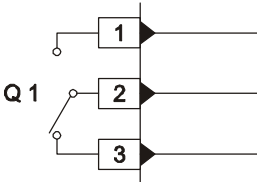

Capacity 5A/250V~ for resistive loads

Relay output Q2

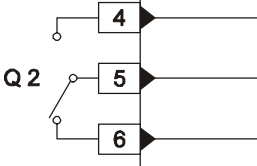

Capacity 5A/250V~ for resistive loads

SSR output Q2

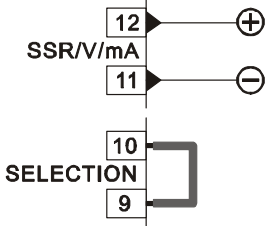

SSR command 12V/30mA

⚠ Short-circuit pins 9 and 10 as in the figure to use SSR output

Q2 output in mA or Volt

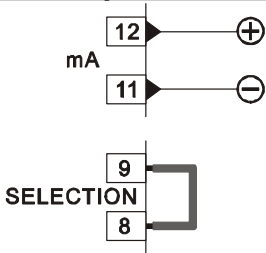

Linear output in **mA** configurable using parameters as command (Parameter `cout`) or retransmission of process or setpoint (Parameter `rEtr.`).

⚠ Short-circuit pins 8 and 9 as in the figure to use linear output in mA.

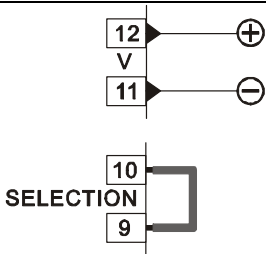

Linear output in **Volt** configurable using parameters as command (Parameter `cout`) or retransmission of process or setpoint (Parameter `rEtr.`).

⚠ Short-circuit pins 9 and 10 as in the figure to use linear output in Volt

Amperometric Transformer Input

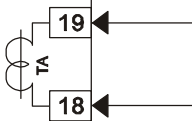

- Input 50mA for amperometric transformer
- Sampling time 80ms
- Configurable by parameters

Digital input (1)

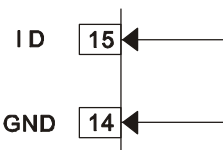

Combined use of digital input and TA input

Digital input according to parameter `dGt. i`

⚠ This combined use is possible only with sensors TC, 0...10V, 0/4...20mA, 0...40mV.

Digital input (2)

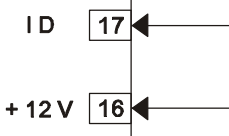

Use of digital input without TA input

Digital input according to parameter `dGt. i`.

6 Displays and keys functions

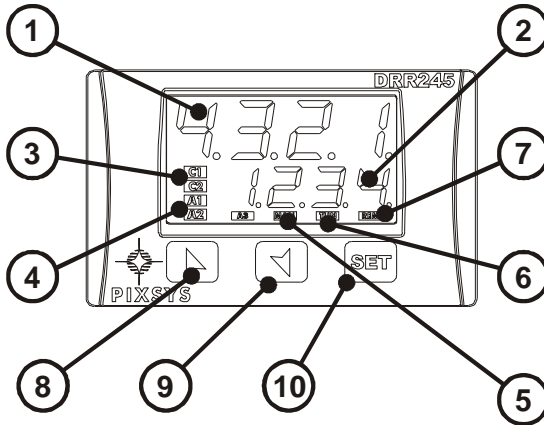







6.1 Numeric Indicators (Displays)

1		Normally displays the process. During the configuration phase, it displays the parameter being inserted
2		Normally displays the setpoint. During the configuration phase, it displays the parameter value being inserted.

6.2 Meaning of Status Lights (Led)

3	 	ON when the output command is on. C1 with relay/SSR/mA/Volt command or C1 (open) and C2 (close) for a motorised valve
4	 	ON when the corresponding alarm is on.
5		ON when the “Manual” function is on.
6		ON when the controller is running an “Autotuning” cycle.
7		ON when the controller communicates via serial port.





6.3 Keys

8		<ul style="list-style-type: none">• Allows to increase the main setpoint.• During the configuration phase, allows you to slide through parameters. Together with the  key it modifies them.• Pressed after the  key it allows to increase the alarm setpoint.
9		<ul style="list-style-type: none">• Allows to decrease the main setpoint.• During the configuration phase, allows to slide through parameters. Together with the  key it modifies them.• Pressed after the  key it allows to decrease the alarm setpoint.
10		<ul style="list-style-type: none">• Allows to display the alarm setpoint and runs the autotuning function.• Allows to vary the configuration parameters

7 Controller Functions

7.1 Modifying Main Setpoint and Alarm Setpoint Values

The setpoint value can be changed from keyboard as follows:

	Press	Effect	Operation
1	 or 	Value on display 2 changes	Increases or decreases the main setpoint
2		Visualize alarm setpoint on display 1	
3	 or 	Value on display 2 changes	Increases or decreases the alarm setpoint value

7.2 Auto-tune



The Tuning procedure calculates the controller parameters and can be manual or automatic according to selection on parameter 57

`tunE`).

7.3 Manual Tuning

The manual procedure allows the user greater flexibility to decide when to update PID algorithm work parameters. The procedure can be activated in two ways.

- **By running Tuning from keyboard:**

Press the  key until display 1 shows the writing `tunE` with display 2 showing `OFF`, press , display 2 shows `on`. The `TUN` led switches on and the procedure begins.

- **By running Tuning from digital input:**

Select `tunE` on parameter 61 `dct.u`.



On first activation of digital input (commutation on front panel) the `TUN` led switches on and on second activation switches off.

7.4 Automatic Tuning

Automatic tuning activates when the controller is switched on or when the setpoint is modified to a value over 35%.

To avoid an overshoot, the threshold where the controller calculates the new PID parameters is determined by the setpoint value minus the “Set Deviation Tune” (see Parameter 58 `sdct.u`).

To exit Tuning and leave the PID values unchanged, just press the

 key until display 1 shows the writing `tunE` with the display showing `on`, press , display 2 shows `OFF`.

The `TUN` led switches off and the procedure finishes.

7.5 Soft Start

To reach the setpoint the controller can follow a gradient expressed in units (e.g. degree/ hours).

Set the increase value in parameter 62 **GrAd** with the desired units/hours; only on **subsequent activation** the controller uses the soft start function.



Automatic/manual tuning cannot be enabled if the Soft start is active.

7.6 Automatic/Manual Regulation for % Output Control

This function allows to select automatic functioning or manual command of the output percentage.

With parameter 60 **Auto**, you can select two methods.

1. **The first selection** **En** allows you to enable the  key with the writing **P.---** on display 1, while display two shows **Auto**.

Press the  key to show **MAN**; it is now possible, during the process display, to change the output percentage using the keys  and . To return to automatic mode, using the same procedure, select **Auto** on display 2: the **MAN** led switches off and functioning returns to automatic mode.

2. **The second selection** **EnSt** enables the same functioning, but with two important variants:
 - If there is a temporary lack of voltage or after switch-off, the manual functioning will be maintained as well as the previously set output percentage value.
 - If the sensor breaks during automatic functioning, the controller moves to manual mode while maintaining the output percentage command unchanged as generated by the PID immediately before breakage.

7.7 Pre-programmed cycle

The pre-programmed cycle function activates by setting `PrCY` or `PcSS` in parameter 59 `oPna`.

First option `PrCY` : the controller reaches setpoint1 basing on the gradient set in parameter 62 `GrAd`, then it reaches maximum power up to setpoint2. When the process reaches maximum power, this setpoint is maintained for the time set in parameter 63 `nAtE`. On expiry, the command output is disabled and the controller displays `StOp`.

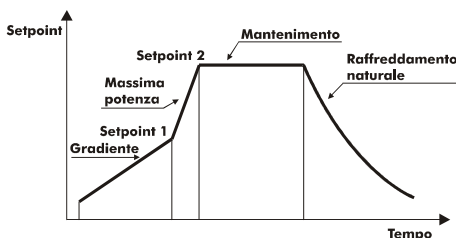

The cycle starts at each activation of the controller, or via digital input if it is enabled for this type of functioning (see parameter 61 `dCtE`).

Second option `PcSS` : start-up is decided only on activation of the digital input, according to the setting of parameter 61 `dCtE`. On start-up, the controller reaches setpoint 1 basing on the gradient set in parameter 62 `GrAd`. When the process reaches this gradient, it is maintained for the time set in parameter 63 `nAtE`. On expiry, the command output is disabled and the controller displays `StOp`.

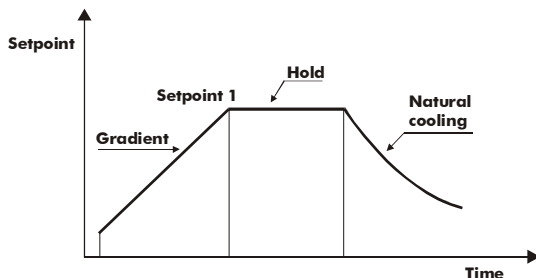



7.8 Memory Card

Parameters and setpoint values can be duplicated from one controller to another using the Memory card.

There are two methods:

- With the controller connected to the power supply
Insert the memory card **when the controller is off.**

On activation display 1 shows `nEno` and display 2 shows `----`
(Only if the correct values are saved in the memory card). By

pressing the  key display 2 shows `LoAd`, then confirm using the  key. The controller loads the new data and starts again.

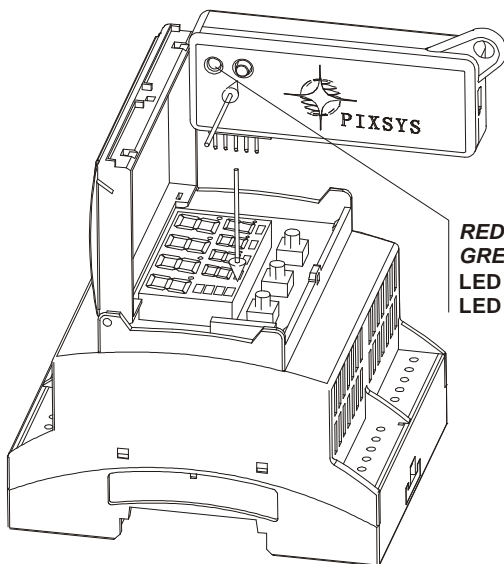

RED LIGHT: waiting for programming

GREEN LIGHT: done

LED ROSSO: acceso in programmazione

LED VERDE: programmazione eseguita

- With the controller not connected to power supply.

The memory card is equipped with an internal battery with an autonomy of about 1000 uses.

Insert the memory card and press the programming buttons.

When writing the parameters, the led turns red and on completing the procedure it changes to green. It is possible to repeat the procedure without any particular attention

Updating Memory Card

To *update* the memory card values, follow the procedure described in the first method, setting display 2 to so as not to load the parameters on controller².

Enter configuration and **change at least one parameter**.

Exit configuration. Changes are saved automatically.

8 LATCH ON Function

For use with input (potentiometer 6K) and (potentiometer 150K) and with linear input (0...10V, 0...40mV, 0/4...20mA), you can associate start value of the scale (parameter 6) to the minimum position of the sensor and value of the scale end (parameter 7) to the maximum position of the sensor (parameter 8 configured as).













It is also possible to fix the point in which the controller will display 0 (however keeping the scale range between and) using the “virtual zero” option by setting or in parameter 8 . If you set the virtual zero will reset after each activation of the tool; if you set the virtual zero remains fixed once tuned.

To use the LATCH ON function configure as you wish the parameter .³

For the calibration procedure refer to the following table:

² If on activation the controller does not display it means no data have been saved on the memory card, but it is possible to update values.

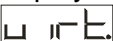
³ The tuning procedure starts by exiting the configuration after changing the parameter.

	Press	Effect	Operation
1		Exit parameters configuration. Display 2 shows the writing  .	Position the sensor on the minimum functioning value (associated with )
2		Set the value to minimum. The display shows  .	Position the sensor on the maximum functioning position (associated with )
3		Set the value to maximum. The display shows  .	To exit the standard procedure press  . For “virtual zero” settings position the sensor on the zero point.
4		Set the virtual zero value. The display shows  . N.B.: for selection of  the procedure in point 4 should be followed on each re-activation.	To exit the procedure press  .



8.1 Loop Break Alarm on Amperometric Transformer TA



This function allows to measure load current and to manage an alarm during malfunctioning with power in short circuit or always off. The amperometric transformer connected to terminals 15 and 16 must be 50mA (sampling time 80ms).

- Set scale end value of the amperometric transformer in Amperes on parameter 47
- Set the intervention threshold of the Loop break alarm in Amperes on parameter 48
- Set the intervention delay time of the Loop break alarm on parameter 49
- You can associate the alarm with a relay by setting the parameter , or as

If a remote control switch or SSR remains closed, the controller signals the fault by showing on display 2 (alternatively with a command setpoint).

If instead the power stage remains open, or the load current is lower than the value set on , the controller shows on display.

You can display the current absorbed during the closure phase of the power stage.

	Press	Effect	Operation
1		This key enables to scroll on display 2 the output percentage, auto/man selection, setpoint and alarms	Press  until the writing <input type="text" value="ANEA"/> appears on display 1 and display 2 shows the current in amperes (<input type="text" value="EA"/> > 0). The value is also maintained when no current circulates on the load.

8.2 Digital input Functions

Digital input is programmable for several functions which are useful to simplify controller operability. Select the desired function on parameter 62 `DIGT. 1`.

1. Hold function (enabled by setting `Lcna` or `Lcnc`) allows to lock the reading of sensors when the digital input is active (useful for wide ranging oscillation on less significant values). During the lock phase, display 2 flashes and shows `Loct`.
2. Enables/disables the autotuning function from digital input if the parameter `EwnE` is set on `NA.`.
3. Enable regulation with `rna` or `rnc`.
4. Switch from automatic to manual functioning if `AwnA` is set on `En.` or `EnSt.`.
5. Start of pre-programmed cycle (see paragraph 7.7) with `SESt.`.
6. Change setpoint function.

This function is useful where there are 2 to 4 working thresholds required during system functioning without having to press the arrow keys.

To enable the function use the parameter `OPna`, by selecting the number of setpoints desired (no. thresholds switch). They can be switched during functioning by pressing the  key.

N.B.: For electrical wiring of digital input see paragraph 5.1

The digital input functions **are not** available with sensors PT100 and NI100 if input is used also for amperometric transformer TA.

8.3 Dual Action Heating-Cooling

DRR245 is also suitable also for systems requiring a combined heating-cooling action.

The command output must be configured as Heating PID ($\text{ACTE} = \text{HEAT}$ and with a PB greater than 0), and one of the alarms (AL. 1 , AL. 2 or AL. 3) must be configured as COOL . The command output must be connected to the actuator responsible for heat, while the alarm will control cooling action.

The parameters to configure for the Heating PID are:

$\text{ACTE} = \text{HEAT}$ Command output type (Heating)

PB : Heating proportional band

Ti : Integral time of heating and cooling

Td : Derivative time of heating and cooling

TC : Heating time cycle

The parameters to configure for the Cooling PID are the following (example: action associated to alarm1):

$\text{AL. 1} = \text{COOL}$ Alarm1 selection (cooling)

PbN : Proportional band multiplier

Oudb : Overlapping/Dead band

Cotc : Cooling time cycle

The parameter PbN (that ranges from 1.00 to 5.00) determines the proportional band of cooling basing on the formula:

Cooling proportional band = $\text{PB} * \text{PbN}$

This gives a proportional band for cooling which will be the same as heating band if $\text{PbN} = 1.00$, or 5 times greater if $\text{PbN} = 5.00$.

The **integral time and derivative time** are the same for both actions.

The parameter Oudb determines the percentage overlapping between the two actions. For systems in which the heating output and cooling output must never be simultaneously active a dead band ($\text{Oudb} \leq 0$) must be configured, and vice versa you can configure an overlapping ($\text{Oudb} > 0$).

The following figure shows an example of dual action PID (heating-cooling) with $E_i = 0$ and $E_d = 0$.

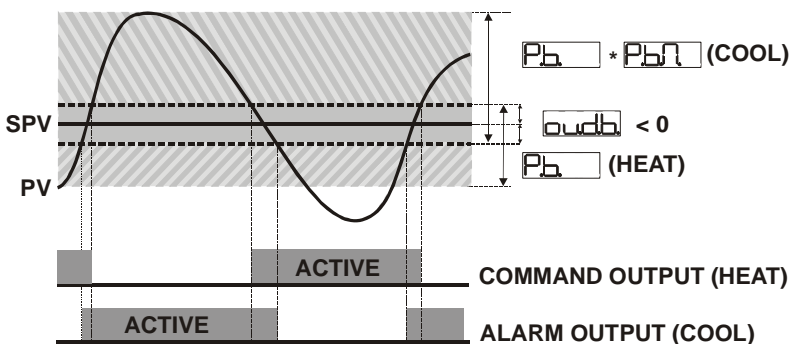
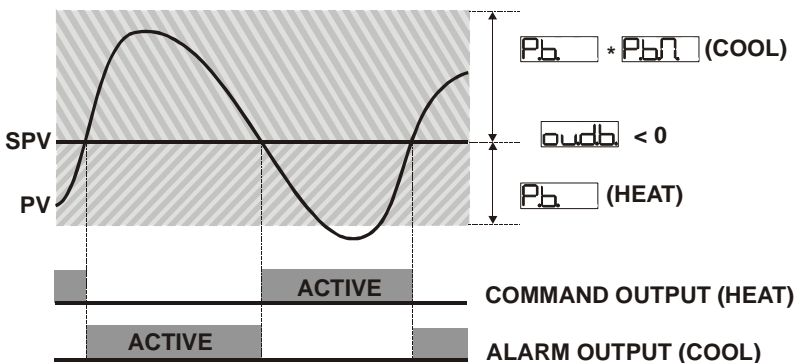
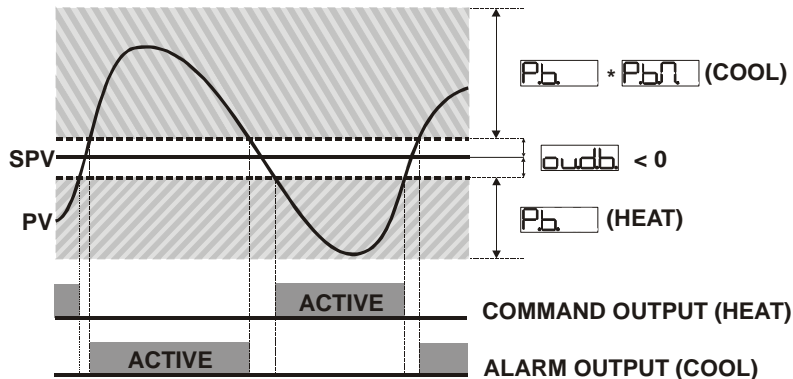

The parameter `catc` has the same meaning as the heating time cycle `tc`.

The parameter `coof` (cooling fluid) pre-selects the proportional band multiplier `Pbn` and the cooling PID time cycle `catc` basing on the type of cooling fluid:

<code>coof</code>	Cooling fluid type	<code>Pbn</code>	<code>catc</code>
Air	Air	1.00	10
oil	Oil	1.25	4
H ₂ O	Water	2.50	2

Once selected, the parameter `coof`, the parameters `Pbn`, `oudb` and `catc` can however be changed.

9 Serial Communication

DRR245-21ABC-T is equipped with with RS485 and can receive/broadcast data via serial communication using MODBUS RTU protocol. The device can only be configured as a Slave. This function enables the control of multiple controllers connected to a supervisory system (SCADA).

Each controller responds to a master query only if the query contains the same address as that in the parameter `SLAd`. The addresses permitted range from 1 to 254 and there must not be controllers with the same address on the same line.

Address 255 can be used by the master to communicate with all the connected equipment (broadcast mode), while with 0 all the devices receive the command, but no response is expected.

DRR245 can introduce a delay (in milliseconds) in the response to the master request. This delay must be set on parameter 72 `SEdE`.

Each parameter change is saved by the controller in the EEPROM memory (100000 writing cycles), while the setpoints are saved with a delay of ten seconds after the last change.

NB: Changes made to words that are different from those reported in the following table can lead to malfunction.

Features of protocol Modbus RTU

<i>Baud-rate</i>	Selectable on parameter 70 <input type="text" value="bdrte"/> <input type="text" value="480"/> 4800bit/sec <input type="text" value="960"/> 9600bit/sec <input type="text" value="1920"/> 19200bit/sec <input type="text" value="2880"/> 28800bit/sec <input type="text" value="3840"/> 38400bit/sec <input type="text" value="5760"/> 57600bit/sec
<i>Format</i>	8, N, 1 (8bit, no parity, 1 stop)
<i>Supported functions</i>	WORD READING (max 20 word) (0x03, 0x04) SINGLE WORD WRITING (0x06) MULTIPLE WORDS WRITING (max 20 word) (0x10)

The list below includes all the available addresses:

RO = Read Only

R/W = Read / Write

WO = Write Only

Modbus address	Description	Read Write	Reset value
0	Device type	RO	EEPROM
1	Software version	RO	EEPROM
5	Slave Address	R/W	EEPROM
6	Boot version	RO	EEPROM
50	Automatic addressing	WO	-
51	System code comparison	WO	-
1000	Process (with tenths of degree for temperature sensors; digits for linear sensors)	RO	?
1001	Setpoint1	R/W	EEPROM
1002	Setpoint2	R/W	EEPROM
1003	Setpoint3	R/W	EEPROM
1004	Setpoint4	R/W	EEPROM
1005	Alarm1	R/W	EEPROM
1006	Alarm2	R/W	EEPROM
1007	Alarm3	R/W	EEPROM
1008	Setpoint gradient	RO	EEPROM

1009	Relay status (0=off, 1=on) Bit 0 = relay Q1 Bit 1 = relay Q2 Bit 2 = reserved Bit 3 = SSR	RO	0
1010	Heating output percentage (0-10000)	RO	0
1011	Cooling output percentage (0-10000)	RO	0
1012	Alarms status (0=none, 1=active) Bit0 = Alarm 1 Bit1 = Alarm 2	RO	0
1013	Manual reset: write 0 to reset all alarms. In reading (0=not resettable, 1=resettable): Bit0 = Alarm 1 Bit1 = Alarm 2	WO	0
1014	Error flags Bit0 = Eeprom writing error Bit1 = Eeprom reading error Bit2 = Cold junction error Bit3 = Process error (sensor) Bit4 = Generic error Bit5 = Hardware error Bit6 = L.B.A.O. error Bit7 = L.B.A.C. error	RO	0
1015	Cold junction temperature (tenths of degree)	RO	?
1016	Start/Stop 0=controller in STOP 1=controller in START	R/W	0
1017	Lock conversion ON/OFF 0=Lock conversion off 1=Lock conversion on	R/W	0
1018	Tuning ON/OFF 0=Tuning off 1=Tuning on	R/W	0
1019	Automatic/manual selection 0=automatic ; 1>manual	R/W	0
1020	TA current ON (Ampere with tenths)	RO	?
1021	TA current OFF (Ampere with tenths)	RO	?
1022	OFF LINE ¹ time (milliseconds)	R/W	0
1023	Instant Current (Ampere)	RO	0

¹ If value is 0, the control is disabled. If different from 0, it is the max. time which can elapse between two pollings before the controller goes off-line.
If it goes off-line, the controller returns to Stop mode, the control output is disabled but the alarms are active

















2001	Parameter 1	R/W	EEPROM
2002	Parameter 2	R/W	EEPROM
2072	Parameter 72	R/W	EEPROM
3000	Disabling serial control of machine ²	WO	0
3001	First word display1 (ascii)	R/W	0
3002	Second word display1 (ascii)	R/W	0
3003	Third word display1 (ascii)	R/W	0
3004	Fourth word display1 (ascii)	R/W	0
3005	Fifth word display1 (ascii)	R/W	0
3006	Sixth word display1 (ascii)	R/W	0
3007	Seventh word display1 (ascii)	R/W	0
3008	Eighth word display1 (ascii)	R/W	0
3009	First word display2 (ascii)	R/W	0
3010	Second word display2 (ascii)	R/W	0
3011	Third word display2 (ascii)	R/W	0
3012	Fourth word display2 (ascii)	R/W	0
3013	Fifth word display2 (ascii)	R/W	0
3014	Sixth word display2 (ascii)	R/W	0
3015	Seventh word display2 (ascii)	R/W	0
3016	Eight word display2 (ascii)	R/W	0
3017	Word LED Bit 0 = LED C1 Bit 1 = LED C2 Bit 2 = LED A1 Bit 3 = LED A2 Bit 4 = LED A3 Bit 5 = LED MAN Bit 6 = LED TUN Bit 7 = LED REM	R/W	0
3018	Word keys (write 1 to command keys) Bit 0 =  Bit 1 =  Bit 2 = 	R/W	0
3019	Word serial relay Bit 0 = relay Q1 Bit 1 = relay Q2	R/W	0
3020	Word SSR serial (0=off, 1=on)	R/W	0
3021	Word output 0...10V serial (0...10000)	R/W	0
3022	Word output 4...20mA serial (0...10000)	R/W	0

² By writing 1 on this word, the effects of the writing are cancelled on all the Modbus addresses from 3001 to 3022. Control therefore returns to the controller.

10 Configuration

10.1 Modify Configuration Parameter

For configuration parameters see paragraph 11.

	Press	Effect	Operation
1	 For 3 seconds	Display 1 shows  with the 1st digit flashing, while display 2 shows  .	
2	 or 	Change the flashing digit and move to the next one using the  key.	Enter password 
3	 To confirm	Display 1 shows the first parameter and display 2 shows the value.	
4	 or 	Slide up/down through parameters	
5	 +  or 	Increase or decrease the value displayed by pressing firstly  and then an arrow key.	Enter the new data which will be saved on releasing the keys. To change another parameter return to point 4.
6	 +  Simultaneously	End of configuration parameter change. The controller exits from programming.	

11 Table of Configuration Parameters

no.	Display	Parameter description	Entering range
1	<div style="border: 1px solid black; padding: 2px; display: inline-block;">COUT</div> Command Output	Select command output type	<div style="border: 1px solid black; padding: 2px; display: inline-block;">C. 01</div> Default (necessary to use retransmission function) <div style="border: 1px solid black; padding: 2px; display: inline-block;">C. 02</div> <div style="border: 1px solid black; padding: 2px; display: inline-block;">C.SSr</div> <div style="border: 1px solid black; padding: 2px; display: inline-block;">CvAL.</div> <div style="border: 1px solid black; padding: 2px; display: inline-block;">C.420</div> <div style="border: 1px solid black; padding: 2px; display: inline-block;">CQ20</div> <div style="border: 1px solid black; padding: 2px; display: inline-block;">CQ10</div>
	<i>COMMAND</i>	<i>ALARM 1</i>	<i>ALARM 2</i>
	<div style="border: 1px solid black; padding: 2px; display: inline-block;">C. 01</div>	Q1	Q2
	<div style="border: 1px solid black; padding: 2px; display: inline-block;">C. 02</div>	Q2	Q1
	<div style="border: 1px solid black; padding: 2px; display: inline-block;">C.SSr</div>	SSR	Q1
	<div style="border: 1px solid black; padding: 2px; display: inline-block;">CvAL.</div>	Q1(Open) Q2(Close)	SSR
	<div style="border: 1px solid black; padding: 2px; display: inline-block;">C.420</div>	SSR	Q1
	<div style="border: 1px solid black; padding: 2px; display: inline-block;">CQ20</div>	SSR	Q1
	<div style="border: 1px solid black; padding: 2px; display: inline-block;">CQ10</div>	SSR	Q1
2	<div style="border: 1px solid black; padding: 2px; display: inline-block;">SEn</div> Sensor	Configuration of analog input	<div style="border: 1px solid black; padding: 2px; display: inline-block;">E.C. F</div> (Default)Tc-K - 260...1360°C <div style="border: 1px solid black; padding: 2px; display: inline-block;">E.C. S</div> Tc-S -40...1760°C <div style="border: 1px solid black; padding: 2px; display: inline-block;">E.C. r</div> Tc-R -40...1760°C <div style="border: 1px solid black; padding: 2px; display: inline-block;">E.C. J</div> Tc-J -200...1200°C <div style="border: 1px solid black; padding: 2px; display: inline-block;">PE</div> PT100 -100...600°C <div style="border: 1px solid black; padding: 2px; display: inline-block;">PE1</div> PT100 -100...140°C <div style="border: 1px solid black; padding: 2px; display: inline-block;">n1</div> NI100 -60...180°C <div style="border: 1px solid black; padding: 2px; display: inline-block;">nTc</div> NTC10K -40...125°C <div style="border: 1px solid black; padding: 2px; display: inline-block;">PEc</div> PTC1K -50...150°C <div style="border: 1px solid black; padding: 2px; display: inline-block;">PE5</div> PT500 -100...600°C <div style="border: 1px solid black; padding: 2px; display: inline-block;">PE1F</div> PT1000 -100...600°C











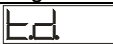

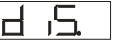

			<div style="display: flex; flex-direction: column; gap: 5px;"> <div style="display: flex; align-items: center;"> <div style="border: 1px solid black; padding: 2px 5px;">0.10</div> <div style="margin-left: 5px;">0...10Volt</div> </div> <div style="display: flex; align-items: center;"> <div style="border: 1px solid black; padding: 2px 5px;">0.20</div> <div style="margin-left: 5px;">0...20mA</div> </div> <div style="display: flex; align-items: center;"> <div style="border: 1px solid black; padding: 2px 5px;">4.20</div> <div style="margin-left: 5px;">4...20mA</div> </div> <div style="display: flex; align-items: center;"> <div style="border: 1px solid black; padding: 2px 5px;">0.40</div> <div style="margin-left: 5px;">0...40mVolt</div> </div> <div style="display: flex; align-items: center;"> <div style="border: 1px solid black; padding: 2px 5px;">Pot.1</div> <div style="margin-left: 5px;">Potentiometer Max 6Kohm</div> </div> <div style="display: flex; align-items: center;"> <div style="border: 1px solid black; padding: 2px 5px;">Pot.2</div> <div style="margin-left: 5px;">Potentiometer Max 150Kohm</div> </div> <div style="display: flex; align-items: center;"> <div style="border: 1px solid black; padding: 2px 5px;">EA</div> <div style="margin-left: 5px;">50mA secondary amperometric transformer</div> </div> </div>
3	<div style="border: 1px solid black; padding: 2px 5px; display: inline-block;">dP.</div> Decimal Point	Select number of displayed decimal points	<div style="display: flex; flex-direction: column; gap: 5px;"> <div style="display: flex; align-items: center;"> <div style="border: 1px solid black; padding: 2px 5px;">0</div> <div style="margin-left: 5px;">Default</div> </div> <div style="border: 1px solid black; padding: 2px 5px; display: inline-block;">00</div> <div style="border: 1px solid black; padding: 2px 5px; display: inline-block;">000</div> <div style="border: 1px solid black; padding: 2px 5px; display: inline-block;">0000</div> </div>
4	<div style="border: 1px solid black; padding: 2px 5px; display: inline-block;">LoLS</div> Lower Limit Setpoint	Lower limit setpoint	-999...+9999 digit* (degrees if temperature) Default: 0.
5	<div style="border: 1px solid black; padding: 2px 5px; display: inline-block;">UpLS</div> Upper Limit Setpoint	Upper limit setpoint	-999...+9999 digit* (degrees if temperature) Default: 1750.
6	<div style="border: 1px solid black; padding: 2px 5px; display: inline-block;">LoL</div> Lower Linear Input	Lower limit An1 only for linear input	-999...+9999 digit* Default: 0.
7	<div style="border: 1px solid black; padding: 2px 5px; display: inline-block;">UpL</div> Upper Linear Input	Upper limit An1 only for linear input	-999...+9999 digit* Default: 1000.
8	<div style="border: 1px solid black; padding: 2px 5px; display: inline-block;">LAtc.</div> Latch On Function	Automatic setting of limits for Linear input	<div style="display: flex; flex-direction: column; gap: 5px;"> <div style="display: flex; align-items: center;"> <div style="border: 1px solid black; padding: 2px 5px;">dLS</div> <div style="margin-left: 5px;">(Disabled) Default</div> </div> <div style="display: flex; align-items: center;"> <div style="border: 1px solid black; padding: 2px 5px;">Std</div> <div style="margin-left: 5px;">(Standard)</div> </div> <div style="display: flex; align-items: center;"> <div style="border: 1px solid black; padding: 2px 5px;">u0St.</div> <div style="margin-left: 5px;">(Virtual Zero Stored)</div> </div> <div style="display: flex; align-items: center;"> <div style="border: 1px solid black; padding: 2px 5px;">u0In</div> <div style="margin-left: 5px;">(Virtual Zero Initialized)</div> </div> </div>
9	<div style="border: 1px solid black; padding: 2px 5px; display: inline-block;">oCAL</div> Offset Calibration	Offset calibration Number added to displayed value of process (normally	-999...+1000 digit* for linear sensors and potentiometers. -200.0...+100.0 0 tenths for temperature sensors.

* The display of the decimal point depends on the setting of parameter SEn

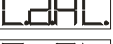
and the parameter dP..

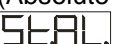
		corrects the room temperature value)	
10	GCAL Gain Calibration	Gain calibration Value multiplied with process value to perform calibration on working point	-10.0%...+10.0% Default: 0.0.
11	ACTE Action type	Regulation type	HEAT : Heating (N.O.) Default COOL : Cooling (N.C.) HOOS : HEat Off Over Setpoint
12	CRE Command Reset	Type of reset for state of command contact (always automatic in PID functioning)	ARE (Automatic Reset) Default PRE (Manual Reset) PRE.S (Manual Reset Stored)
13	CESE Command State Error	State of contact for command output in case of error	CO Default CC
14	CLD Command Led	State of the OUT1 led corresponding to the relevant contact	CO CC Default
15	CHY Command Hysteresis	Hysteresis in ON/OFF or dead band in P.I.D.	-999...+999 digit* (decimi di grado se temperatura) Default: 0.0.
16	CDL Command Delay	Command delay (only in ON/OFF functioning). (In case of servo valve it also functions in PID and represents the delay between the opening and closure of the two contacts)	-180...+180 seconds (tenths of second in case of servo valve). Negative: delay in switching off phase. Positive: delay in activation phase Default: 0.
17	CS.P. Command Setpoint Protection	Allows or not to change the command setpoint value	FREE Default Loct
18	PB Proportional Band	Proportional band Process inertia in units (E.g.: if temperature is in °C)	0 on/off se E. I Equal to 0 . Default 1-9999 digit* (degrees if temperature)



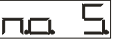
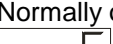
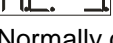
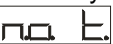







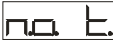

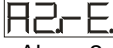

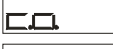

* The display of the decimal point depends on the setting of parameter **SEn** and parameter **dP.**

19	 Integral Time	Integral time. Process inertia in seconds	0.0-999.9 seconds (0 integral disabled) Default: 0.
20	 Derivative Time	Derivative time. Normally ¼ the integral time	0.0-999.9 seconds (0 derivative disabled) Default: 0.
21	 Cycle Time	Cycle time (for PID on remote control switch 10/15sec, for PID on SSR 1 sec) or servo time (value declared by servo-motor manufacturer)	1-300 seconds Default: 10.
22	 Output Power Limit	Limit of output power	10-100 % Default: 100.
23	 Alarm 1	Alarm 1 selection. Intervention of the alarm is associated with AL1	 (Disabled) Default  (Absolute Alarm)  (Band Alarm)  (High Deviation Alarm)  (Low Deviation Alarm)  (Absolute Command setpoint Alarm)  (Start Alarm) Active in Run  (Cooling)  (Loop Break Alarm)
24	 Alarm 1 State Output	Alarm 1 output contact and intervention type	 (n.o. start) Default Normally open, active at start  Normally closed, active at start  (n.o. threshold) Normally open, active on reaching alarm ⁴  (n.c. threshold) Normally closed on reaching alarm ⁴⁴

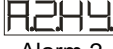

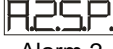
⁴ On activation, the output is inhibited if the controller is in alarm mode. Activates only if alarm condition reappears, after that it was restored.

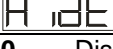
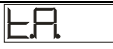















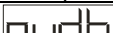









25	A r E. Alarm 1 Reset	Type of Reset for contact of alarm 1.	A r E. (Automatic Reset)Default r E. (Manual Reset) r E S. (Manual Reset Stored)
26	A. I S E. Alarm 1 State Error	State of contact for alarm 1 output in case of error	CO Default CC.
27	A. I L d Alarm 1 Led	Defines the state of the OUT2 led corresponding to the relative contact	CO CC. Default
28	A. I H Y Alarm 1 Hysteresis)	Alarm 1 hysteresis	-999...+999 digit* (tenths of degree if temperature). Default: 0.
29	A. I D E. Alarm 1 Delay	Alarm 1 delay	-180...+180 Seconds Negative: delay in alarm output phase. Positive: delay in alarm entry phase. Default: 0.
30	A. I S P. Alarm 1 Setpoint Protection	Alarm 1 set protection. Does not allow user to modify setpoint	FrEE Default Loct H idE
31	AL. 2 Alarm 2	Alarm 2 selection. Alarm intervention is associated with AL2	d i S (Disabled) Default A. AL. (Absolute Alarm) b. AL. (Band Alarm) H d AL. (High Deviation Alarm) L d AL. (Low Deviation Alarm) A c AL. (Absolute Command setpoint Alarm) S t AL. (Start Alarm) COOL (Cooling) L b A. (Loop Break Alarm)
32	A 2 S o Alarm 2 State	Alarm 2 output contact and intervention type	no S (n.o. start) Default Normally open, active at start

* The display of the decimal point depends on the setting of parameter **SEn.** and parameter **dP.**

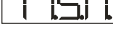













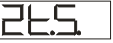



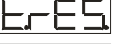
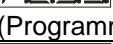

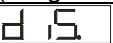

	Output		 (n.c. start) Normally closed, active at start  (n.o. threshold) Normally open, active on reaching alarm ⁵  (n.c. threshold) Normally closed, active on reaching alarm ⁵
33	 Alarm 2 Reset	Type of Reset for contact of alarm 2	 (Automatic Reset) Default  (Manual Reset)  (Manual Reset Stored)
34	 Alarm 2 State Error	State of contact for alarm 2 output in case of error	 Default 
35	 Alarm 2 Led	State of OUT2 led corresponding to relative contact	  Default
36	 Alarm 2 Hysteresis	Alarm 2 hysteresis	-999...+999 digit* (tenths of degree if temperature). Default: 0.
37	 Alarm 2 Delay	Alarm 2 delay	-180...+180 Seconds Negative: delay in alarm output phase. Positive: delay in alarm entry phase. Default: 0.
38	 Alarm 2 Setpoint Protection	Alarm 2 set protection. Does not allow operator to change value set	 Default  
47	 Amperometric Transformer	Activation and scale range of amperometric transformer	0 Disabled 1-200 Ampere Default: 0.
48	 Loop Break	Intervention threshold of Loop break alarm	0.0-200.0 Ampere Default: 50.0.

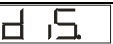

⁵ On activation, the output is inhibited if the controller is in alarm mode. Activates only if alarm condition reappears, after that it was restored.

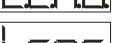

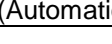
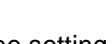



















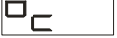

* The display of the decimal point depends on the setting of parameter  and parameter .

	Alarm Threshold		
49	 Loop Break Alarm Delay	Delay time for Loop break alarm intervention	00.00-60.00 mm.ss Default: 01.00.
50	 Cooling Fluid	Type of cooling fluid	 Default  
51	 Proportional Band Multiplier	Proportional band multiplier	1.00-5.00 Default: 1.00.
52	 Overlap/Dead Band	Overlapping/Dead band	-20.0-50.0% Default: 0.
53	 Cooling Cycle Time	Cycle time for cooling output	1-300 seconds Default: 10.
54	 Conversion Filter	ADC filter: number of means on analog-digital conversions	 (Disabled)  (2 Samples Mean)  (3 Samples Mean)  (4 Samples Mean)  (5 Samples Mean)  (6 Samples Mean)  (7 Samples Mean)  (8 Samples Mean)  (9 Samples Mean)  (10 Samples Mean) Default  (11 Samples Mean)  (12 Samples Mean)  (13 Samples Mean)  (14 Samples Mean)  (15 Samples Mean)
55	 Conversion Frequency	Frequency of sampling of analog-digital converter	 (242 Hz)  (123 Hz)

			<input type="checkbox"/> 62 Hz (62 Hz) <input type="checkbox"/> 50 Hz (50 Hz) <input type="checkbox"/> 39 Hz (39 Hz) <input type="checkbox"/> 33.2 Hz (33.2 Hz) <input type="checkbox"/> 19.6 Hz (19.6 Hz) <input type="checkbox"/> 16.7 Hz (16.7 Hz) Default <input type="checkbox"/> 12.5 Hz (12.5 Hz) <input type="checkbox"/> 10 Hz (10 Hz) <input type="checkbox"/> 8.33 Hz (8.33 Hz) <input type="checkbox"/> 6.25 Hz (6.25 Hz) <input type="checkbox"/> 4.17 Hz (4.17 Hz)
56	<input type="checkbox"/> FLE Visualization Filter	Visualisation filter	<input type="checkbox"/> d.s (Disabled) Default <input type="checkbox"/> F. 1 st (First Order) <input type="checkbox"/> 2. SN (2 Samples Mean) <input type="checkbox"/> 3. SN (3 Samples Mean) <input type="checkbox"/> 4. SN (4 Samples Mean) <input type="checkbox"/> 5. SN (5 Samples Mean) <input type="checkbox"/> 6. SN (6 Samples Mean) <input type="checkbox"/> 7. SN (7 Samples Mean) <input type="checkbox"/> 8. SN (8 Samples Mean) <input type="checkbox"/> 9. SN (9 Samples Mean) <input type="checkbox"/> 10. SN (10 Samples Mean)
57	<input type="checkbox"/> TunE Tune	Tuning type selection	<input type="checkbox"/> d.s (Disabled) Default <input type="checkbox"/> Auto (Automatic) PID parameters are calculated at activation and change of set point <input type="checkbox"/> Man (Manual) Launch from keyboard or digital In.

58	 Setpoint Deviation Tune	Select the deviation from the command setpoint, for the threshold used by autotuning to calculate the PID parameters.	0-5000 digit* (tenths of degree if temperature). Default: 10.
59	 Operating Mode	Select operating mode	 (Controller) Default  (Programmed Cycle)  (2 Thresholds Switch)  (2 Thresholds Switch Impulsive)  (3 Thresholds Switch Impulsive)  (4 Thresholds Switch Impulsive)  (Time Reset)  (Programmed Cycle Start/Stop)
60	 Automatic / Manual	Enable automatic/manual selection	 (Disabled) Default  (Enabled)  (Enabled Stored)
61	 Digital Input	Digital input functioning (P59 selection must be  or )	 (Disabled) Default: 0.  (Start/Stop)  (Run n.o.)  (Run n.c.)  (Lock Conversion n.o.)  (Lock Conversion n.c.)  (Tune) Manual  (Auto Manual impulse)  (Automatic Manual Contact)

* The display of the decimal point depends on the setting of the parameter  and the parameter .

62	 Gradient	Increase gradient for soft start or pre-programmed cycle	0 disabled 1-9999 Digit/hour* (degrees/hour with display of tenth if temperature) Default: 0.
63	 Maintenance Time	Maintenance time for pre-programmed cycle.	00.00-24.00 hh.mm Default: 00.00.
64	 User Menu Cycle Programmed	Allows the rise gradient and the maintenance time to be changed from the user menu, in pre-programmed cycle functioning.	 (Disabled) Default  (Gradient)  (Maintenance Time)  (All)
65	 Visualization Type	Select visualization for display 1 and 2	 (1 Process, 2 Setpoint) Default  (1 Process, 2 Hide after 3 sec.)  (1 Setpoint, 2 Process)  (1 Setpoint, 2 Hide after 3 sec.)  (1 Process, 2 Ampere.)
66	 Degree	Selezione tipo gradi	 :Centigrade  :Fahrenheit
67	 Retransmission	Retransmission for output 0-10V or 4...20mA. **Short-circuit pins 8,9,10 Parameters 68 and 69 define the lower and upper limits of the scale	 (Disabled) Default  (Volt Process)  (mA Process)  (Volt Command setpoint)  (mA Command setpoint)  (Volt Output Percentage)  (mA Output Percentage)

** The display of the decimal point depends on the setting of parameter 

and parameter 

			(Volt Alarm 1 setpoint) (mA Alarm 1 setpoint) (Volt Alarm 2 setpoint) (mA Alarm 2 setpoint) (Volt T.A.) (mA T.A.)
68	 Lower Limit Retransmission	Lower limit range of linear output (to rescale value)	-999...+9999 digit* (degrees if temperature) Default: 0.
69	 Upper Limit Retransmission	Upper limit range of linear output (to rescale value)	-999...+9999 digit* (degrees if temperature) Default: 1000.
70	 Baud Rate	Select baud rate for serial communication	48 F 96 F 192 F Default 288 F 384 F 576 F
71	 Slave Address	Select slave address for serial communication	1 – 254 Default: 254.
72	 Serial Delay	Select serial delay	0 – 100 milliseconds Default: 20.

* The display of the decimal point depends on the setting of parameter and parameter .

12 Alarm Intervention Modes

Absolute Alarm or Threshold Alarm (selection $\boxed{A.AL}$)

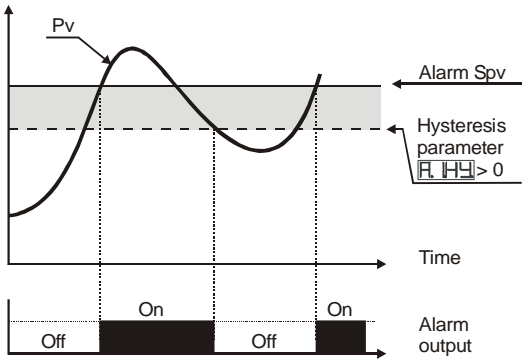

Absolute alarm with controller in heating functioning (Par.11 $\boxed{A.CEE}$ selected \boxed{HEAT}) and hysteresis value greater than "0" (Par.28 $\boxed{A.IH4} > 0$).

N.B.: The example refers to alarm 1; the function can also be enabled for alarm 2.

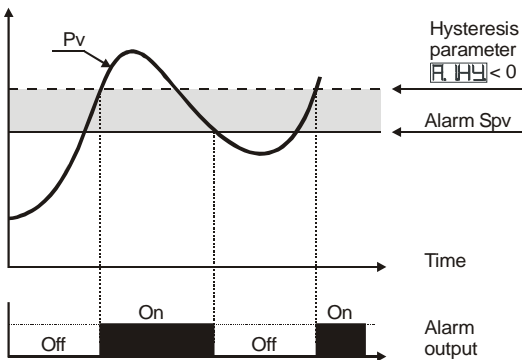

Absolute alarm with controller in heating functioning (Par.11 $\boxed{A.CEE}$ selected \boxed{HEAT}) and hysteresis value less than "0" (Par.28 $\boxed{A.IH4} < 0$).

N.B.: The example refers to alarm 1; the function can also be enabled for alarm 2.

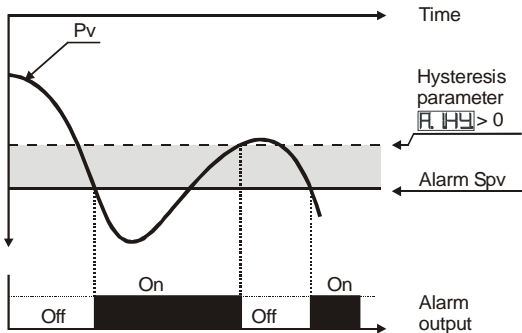

Absolute alarm with controller in cooling functioning (Par.11 $\boxed{A.CEE}$ selected \boxed{COOL}) and hysteresis value greater than "0" (Par.28 $\boxed{A.IH4} > 0$).

N.B.: The example refers to alarm 1; the function can also be enabled for alarm 2.

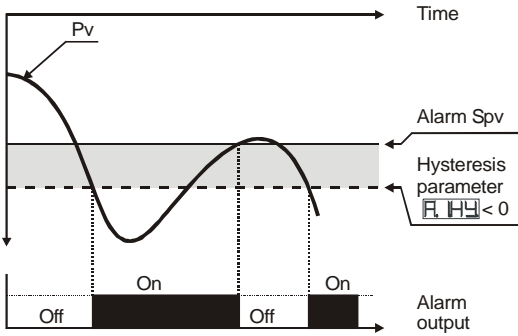

Absolute alarm with controller in cooling functioning (Par.11 `AcEL` selected `COOL`) and hysteresis value less than "0" (Par.28 `A.HY` < 0).

N.B.: The example refers to alarm 1; the function can also be enabled for alarm 2.

Absolute Alarm or Threshold Alarm Referring to Setpoint Command (selection `AcAL`)

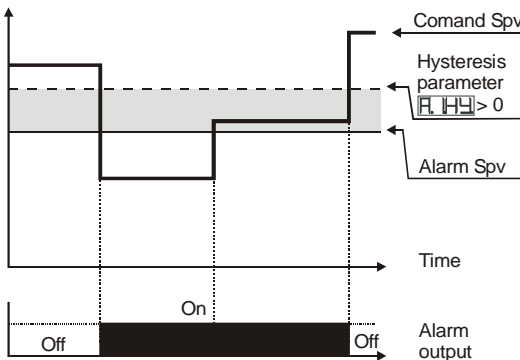

Absolute alarm refers to the command set, with the controller in heating functioning (Par.11 `AcEL` selected `HEAT`) and hysteresis value greater than "0" (Par.28 `A.HY` > 0).

The command set can be changed by pressing the arrow keys on front panel or using serial port RS485 commands.

N.B.: The example refers to alarm 1; the function can also be enabled for alarm 2.

Band Alarm (selection \square AL)

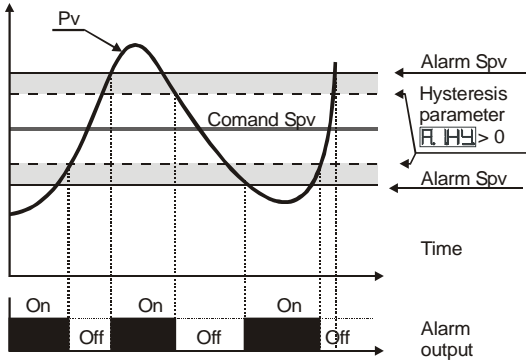

Band alarm hysteresis value greater than "0" (Par.28 $\square \text{AL} > 0$).

N.B.: The example refers to alarm 1; the function can also be enabled for alarm 2.

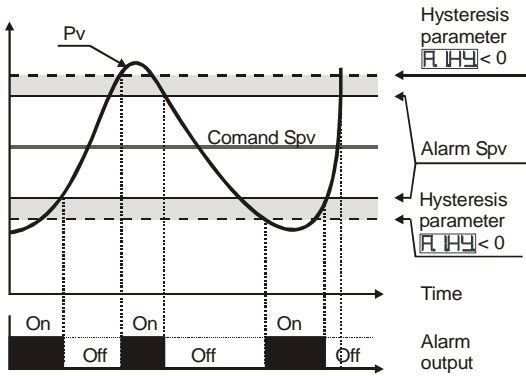

Band alarm hysteresis value less than "0" (Par.28 $\square \text{AL} < 0$).

N.B.: The example refers to alarm 1; the function can also be enabled for alarm 2.

Upper Deviation Alarm (selection $\overline{H2AL}$)

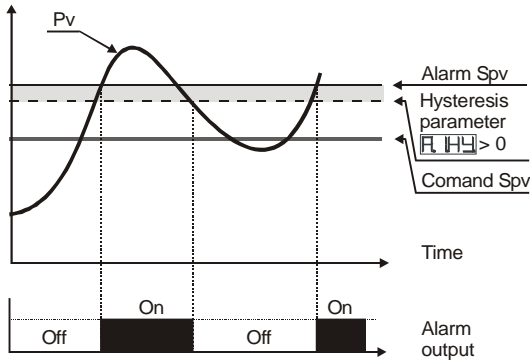

Upper deviation alarm value of alarm setpoint greater than "0" and hysteresis value greater than "0" (Par.28 $\overline{RH9} > 0$).

N.B.:

a) The example refers to alarm 1; the function can also be enabled for alarm 2

b) With hysteresis less than "0" ($\overline{RH9} < 0$) the broken line moves above the alarm setpoint.

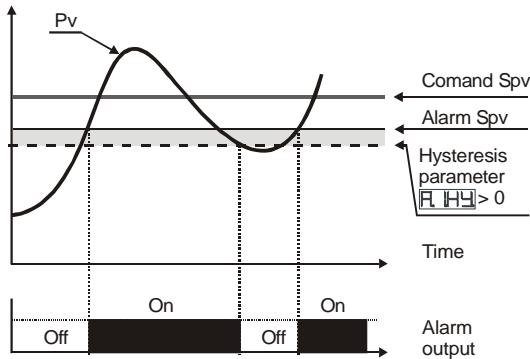

Upper deviation alarm value of alarm setpoint less than "0" and hysteresis value greater than "0" (Par.28 $\overline{RH9} > 0$).

N.B.:

a) The example refers to alarm 1; the function can also be enabled for alarm 2

b) With hysteresis less than "0" ($\overline{RH9} < 0$) the broken line moves above the alarm setpoint.

Lower Deviation Alarm (selection $\overline{H2AL}$)

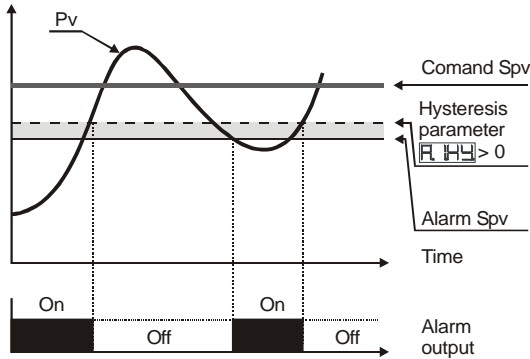

Lower deviation alarm value of alarm setpoint greater than "0" and hysteresis value greater than "0" (Par.28 $\overline{H2AL} > 0$).

N.B.:

- The example refers to alarm 1; the function can also be enabled for alarm 2
- With hysteresis less than "0" ($\overline{H2AL} < 0$) the broken line moves under the alarm setpoint.

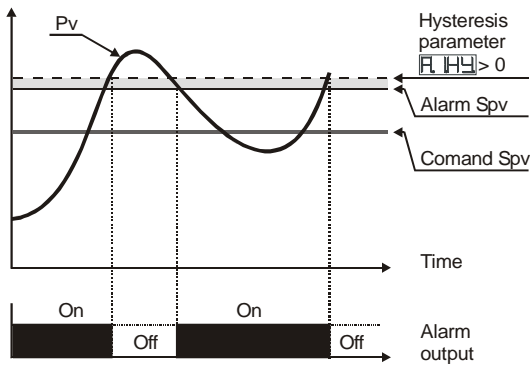

Lower deviation alarm value of alarm setpoint less than "0" and hysteresis value greater than "0" (Par.28 $\overline{H2AL} > 0$).

N.B.:

- The example refers to alarm 1; the function can also be enabled for alarm 2
- With hysteresis value less than "0" ($\overline{H2AL} < 0$) the broken line moves under the alarm setpoint.

13 Table of Anomaly Signals

In case of malfunctioning of the system, the controller switches off the regulation output and displays the type of anomaly.

For example the controller will signal the breakage of any connected thermocouple by displaying **E-05** (flashing) on display. For other notifications, see the table below.

#	Cause	What to do
E-01	Error in E ² PROM cell programming	Call Assistance
E-02	Cold junction sensor fault or room temperature outside of allowed limits.	Call Assistance
E-04	Incorrect configuration data. Possible loss of calibration values.	Check if the configuration parameters are correct.
E-05	Thermocouple open or temperature outside of limits.	Check the connection with the sensors and their integrity.

14 Summary of Configuration parameters

Date:	Model DRR245:
Installer:	System:
Notes:	

c.o.u.t	Command output type selection	
S.E.n	Analog input configuration	
d.P.	Number of decimal points	
L.o.L.S	Lower limit setpoint	
u.P.L.S	Upper limit setpoint	
L.o.L.l	Lower limit range An1 only for linear signals	
u.P.L.l	Upper limit range An1 only for linear signals	
L.A.t.c.	Automatic setting of linear input limits	
o.c.A.L.	Offset calibration	
G.c.A.L.	Gain calibration	
R.c.t.t.	Regulation type	
c. r.E.	Command output reset type	
c. S.E.	Contact state for command output in case of error	
c. L.d	Define the OUT1 led state	
c. H.Y	Hysteresis in ON/OFF or dead band in P.I.D.	
c. d.E.	Command delay	
c. S.P.	Command setpoint protection	
P.b	Proportional band	
I. t	Integral time	
E.d	Derivative time	
t.c.	Cycle time	
o.P.o.L.	Limit of output power %	
A.L. 1	Alarm 1 selection	
A. I.S.o	Alarm 1 output contact and intervention type	
A. r.E.	Reset type of alarm 1 contact.	
A. I.S.E.	State of contact for alarm 1 output	
A. I.L.d	State of OUT2 led	

A1HY	Alarm 1 hysteresis	
A1DE	Alarm1 delay	
A1SP	Alarm 1 set protection	
AL2	Alarm 2 selection	
A2SO	Alarm 2 output contact and intervention type	
A2RE	Reset type of alarm 2 contact	
A2SE	State of contact for alarm 2 output	
A2LD	State of OUT2 led	
A2HY	Alarm 2 hysteresis	
A2DE	Alarm 2 delay	
A2SP	Alarm 2 set protection	
EA	Enabling end scale range of amperometric transformer	
LbAL	Threshold intervention of Loop break alarm	
LbAd	Delay time for Loop break alarm intervention	
COoF	Cooling fluid type	
PbN	Proportional band multiplier	
owdb	Overlapping/Dead band	
COtC	Cycle time for cooling output	
cFLE	Analog converter filter	
cFRn	Sampling frequency of analog converter	
uFLE	Display filter	
tunE	Autotuning type selection	
SdEt	Command setpoint deviation for tuning threshold	
oPNd	Operating mode	
AuNA	Automatic/manual selection	
dGE _v	Digital input functioning	
GrAd	Gradient for soft start	
NAE _v	Cycle maintenance time	
uNcP	Gradient change and maintenance time by user	
uItY	Display data selection	
dEGr	Degree type selection	
rEtr	Retransmission for output 0-10V or 4...20mA	
LoLr	Lower limit range for linear output	

uPLr.	Upper limit range for linear output
bdrt.	Select baud rate for serial communication
SLAd	Select slave address
SEdE	Select the serial delay

Notes / Updates

A series of horizontal dashed lines for writing notes or updates.

PIXSYS

Via Tagliamento, 18

30030 Mellaredo di Pianiga (VE)

www.pixsys.net

e-mail: sales@pixsys.net - support@pixsys.net

Software Rev. 1.03

2300.10.080-RevA 180707

2300.10.080-A